

VolTron 1000V CONNECTOR

TE Connectivity's (TE) VolTron 1000V high voltage sensing connector is specifically designed to use in the Battery Management System (BMS) and Battery Disconnect Units (BDU) to measure voltage across the battery architecture and ecosystem.

The connector's multiple design features, high CTI (Comparative Tracking Index) materials and contact surfaces enhances creep and clearance. This results in high performance value of up to 1000V, strong dielectric strength and capability to use above 5000M sea level, with pollution degree 2 according to IEC 60664-1. The connector complies to LV214, LV215 and USCAR automotive standards.

PRODUCT HIGHLIGHTS

- High Creepage and Clearance distances to help enable high voltage flow
VolTron 1000 connector's adopted high CTI resin material. It makes the product compliant to IEC 60664-1 standard for 1000V DC voltage rating. It mainly support the battery applications for signal measurement
- Miniaturization grade with low profile
The design concept for VolTron 1000V connector is from MaxiBridge connector which is the popular applied in most automotive and industrial application. The horizontal male connector height is only 5.1mm to provide more freedom for Battery Management System (BMS) or other electrical components in the printed circuit board
- Suitable to use in harsh environments and automotive standards to stretch the automotive market, VolTron 1000V connector complies with LV214, LV215 and USCAR automotive standards
- Orange and black Color with mechanical coding
VolTron 1000V connectors are designed with two mechanical coding for minimising errors. Both coding version can be different from the orange and black color
- Reuse MaxiBridge crimp contact
Receptacle contact for VolTron 1000V connector is reused from ERNI MaxiBridge connector series, which is the popular wire to board connector series for automotive application

APPLICATIONS

- BMS
- BDU
- Integrated power electronics
- In broad range of applications where high voltage needs to be measured on a constant basis

PERFORMANCE AND SPECIFICATIONS

PERFORMANCE

Item	Series	VolTron 1000V
Pitch		6.2 mm
Rated voltage (max.)		1000V DC
Rated current (max.)		Actual current carrying capability to be referred from derating table on product specification
Contact resistance		15mΩ Max
Withstanding voltage		2150VDC (LV215) 4800V DC (USCAR)
Operating temperature		-40 °C ~ 150 °C

PRODUCT SPECIFICATION AND INSTRUCTION SHEET

Product specification	108-94917
Product layout requirement	Customer drawing: 544840-E
Application specification	114-94917 (for female contact crimp snap in) 114-94917-1(for female contact crimp tool and cable)

POSITIONS / WIRE SIZE / RATED CURRENT

Positions	Cable size
	0.35mm ² (AWG 22)
2, 5, 6	Original design target minimal 0.5A, Actual current carrying capability to be referred from derating table on product specification

MATERIALS AND PLATING

Category	VolTron 1000V
Contact	Copper alloy
Plating in mating area	PdNi + gold flash
Plastic housing of male connector (PCB side)	PA, orange / black
Plastic housing of female connector (wire side)	PA, orange / black
Retention pin	Copper alloy

FEMALE CONTACT (FROM MAXIBRIDGE CONNECTOR)





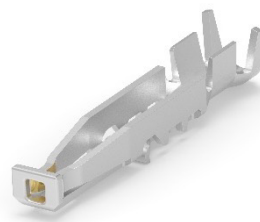













CRIMP CONTACTS

AWG	Wire range		Plating	Female Contact		Applicator and tool	
	mm ²	Outer diameter of insulation (mm)		Strip Form (10000pcs / reel)	Strip Form (500pcs / reel)	Crimping tool (applicator) with mechanical feed	Hand tool
22	0.35	1.20-1.55	Gold flash over PdNi	464762-E	464763-E	817479-E	952050-E



VolTron 1000V CONNECTOR

CONFIGURATIONS

Pos.	Colour	Female housing bulk package		Board-mounting male header Horizontal tape and reel package		Board-Mounting male header Vertical tape and reel package	
		Image	Part Number	Image	Part Number	Image	Part Number
2	Black		544950-E		524226-E		524255-E
	Orange		544951-E		524227-E		524256-E
5	Black		544956-E		524232-E		524261-E
	Orange		544957-E		524233-E		524262-E
6	Black		544958-E		524235-E		524264-E
	Orange		544959-E		524236-E		524265-E

VolTron 1000V CONNECTOR - 6.2 MM PITCH

RELATIVE PRODUCT INFORMATION

Applicable contact...P.2

Performance & specifications...P.2

MATED DIMENSIONS

Units: mm

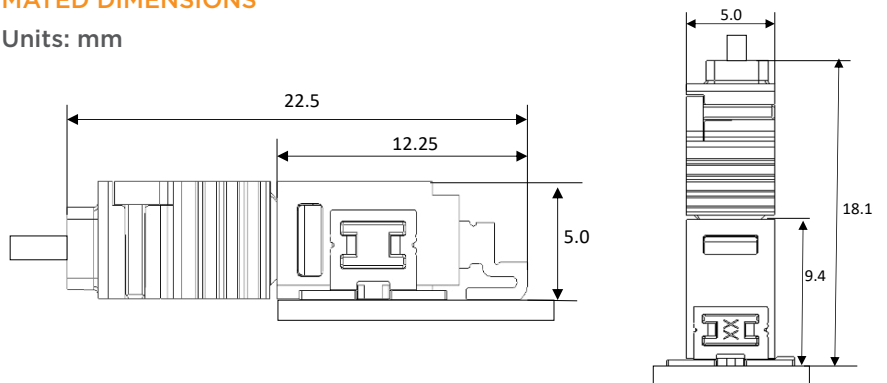

VolTron 1000V CONNECTOR

EXTERNAL DIMENSIONS

Units: mm

Female housing

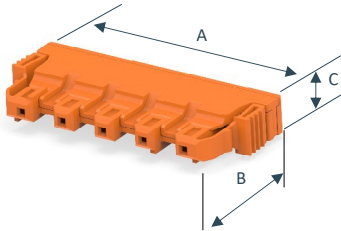

Pos.	Color	Part Number	Dimensions		
			A	B	C
2	Black	544950-E	16.9	16.5	5
	Orange	544951-E			
5	Black	544956-E	35.5	16.5	5
	Orange	544957-E			
6	Black	544958-E	41.7	16.5	5
	Orange	544959-E			

* External dimensions after crimped cable assembly

Board-Mounting male header

Horizontal type

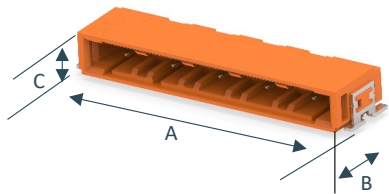

Pos.	Color	Part Number	Dimensions		
			A	B	C
2	Black	524226-E	17.9	12.2	5.1
	Orange	524227-E			
5	Black	524232-E	36.5	12.2	5.1
	Orange	524233-E			
6	Black	524235-E	42.7	12.2	5.1
	Orange	524236-E			

* External dimensions include soldering pins

Vertical type

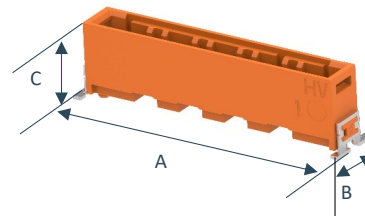

Pos.	Color	Part Number	Dimensions		
			A	B	C
2	Black	524255-E	17.9	7.2	9.4
	Orange	524256-E			
5	Black	524261-E	36.5	7.2	9.4
	Orange	524262-E			
6	Black	524264-E	42.7	7.2	9.4
	Orange	524265-E			

* External dimensions include soldering pins

te.com

ERNI, MaxiBridge, TE Connectivity, TE connectivity (logo) and Every Connection Counts are trademarks owned or licensed by TE Connectivity plc family of companies.

All other logos, products and/or company names referred to herein might be trademarks of their respective owners.

While TE has made every reasonable effort to ensure the accuracy of the information in this document, TE does not guarantee that it is error-free, nor does TE make any other representation, warranty or guarantee that the information is accurate, correct, reliable or current. TE reserves the right to make any changes to the information contained herein without prior notice. TE Connectivity assumes only those obligations set forth in the terms and conditions for this product and shall in no event be liable for any incidental, indirect, or consequential damages arising out of the sale, resale, use, or misapplication of the product. TE expressly disclaims any implied warranties with respect to the information contained herein, including, but not limited to, implied warranties of merchantability or fitness for a particular purpose. Dimensions, specifications and/or information contained herein are for reference purposes only and are subject to change without notice. Consult TE for the latest dimensions, specifications and/or information. Users of TE Connectivity products must make their own assessment as to whether the respective product is suitable for the respective desired application.

©2026 TE Connectivity. All Rights Reserved.

01/26 AK